

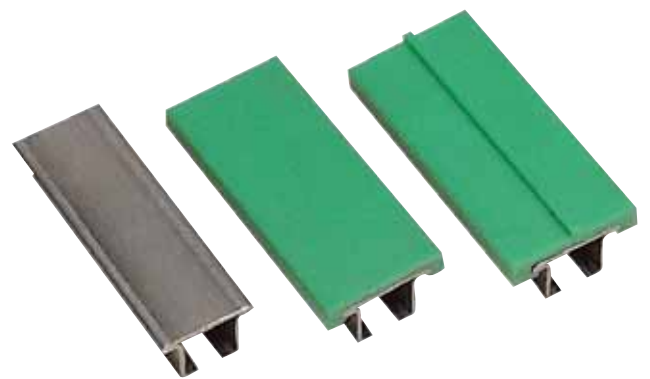

**SYSTEM  
PLAST™**

## Top Quality Extruded Profiles



  
**EMERSON™**  
Industrial Automation

EMERSON. CONSIDER IT SOLVED.

## Quality

System Plast is committed to quality and for extrusion profiles it means top-of-the-range extruders and tools, top quality materials! It takes experienced specialists to set up and control the process; System Plast uses RAM extrusion exclusively. Only RAM extrusion can handle the materials in the right way in order to get proper quality, long-lasting profiles.

It achieves the pressure to get to the required density. It produces profiles that don't only last longer, but perform better as well regarding friction and sliding properties.

## Materials

Only high quality polyethylenes and polyamides are used. Each material for its own specific application. A part of the range is available in green, black and white. As specials black anti-static and anti-bacterial Nolu-Clean is available.

## Nolu-S

Nolu-S is top-of-the-bill. Compared to the standard improved quality of UHMWPE the friction is 20 to 25% lower at least. The detailed graph below even shows a bigger gap in friction and the coefficient is constant as well!

In air-conveyors it has proven to dramatically improve the bottle flow, in heavy applications like spirals it reduced the friction to a level that makes a difference between failing and working! Nolu-S wear strips in conveyors make the operation quieter and smoother, avoiding slip-stick and noise!

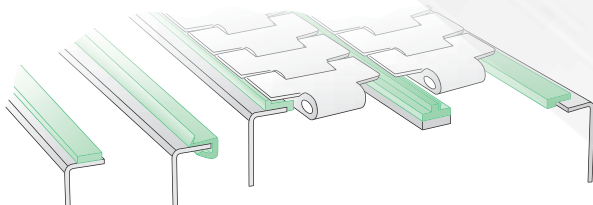
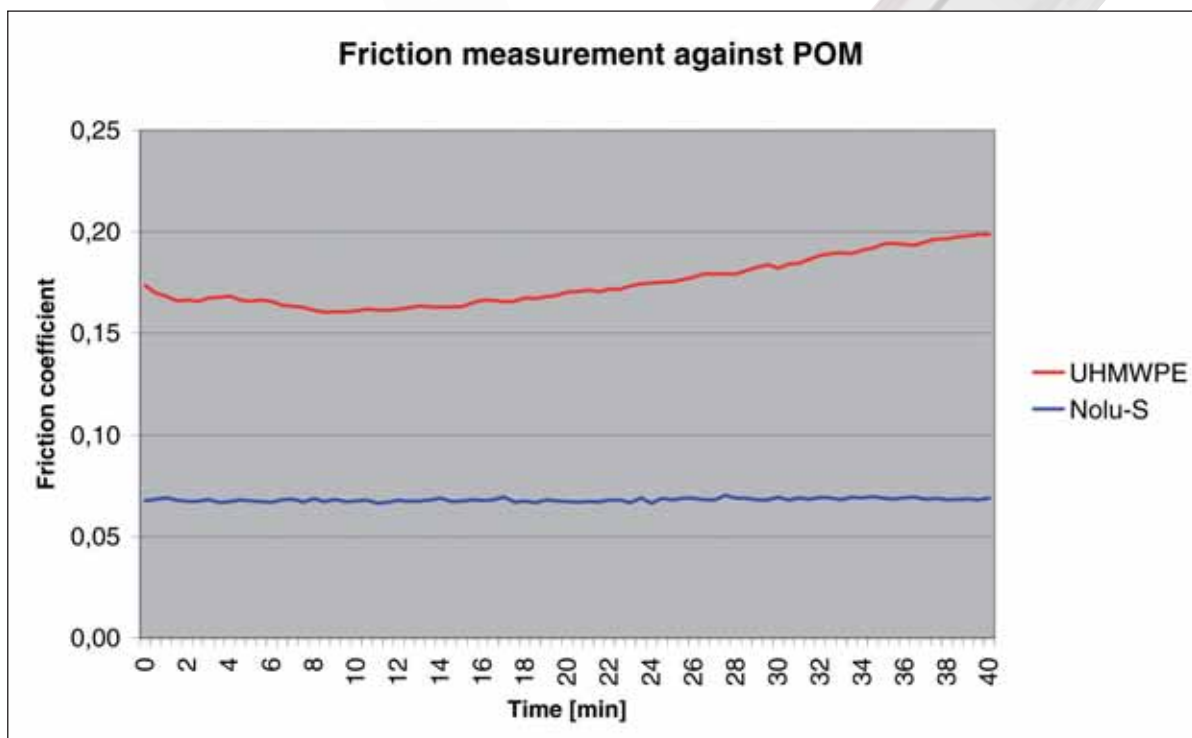

## WEAR STRIPS

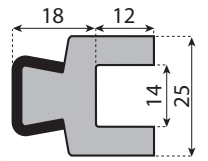
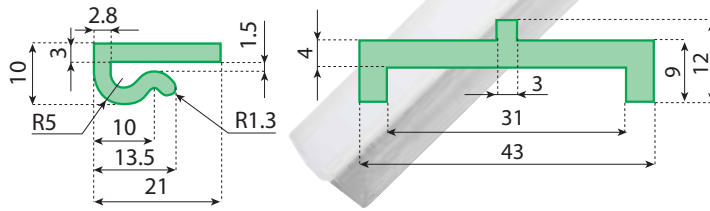
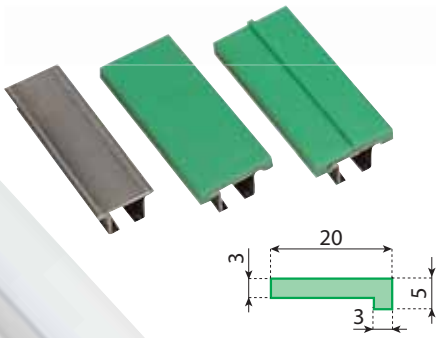

## BAR CAPS

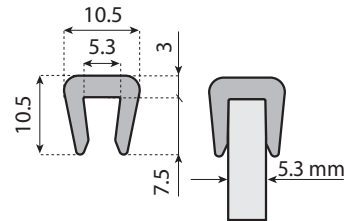
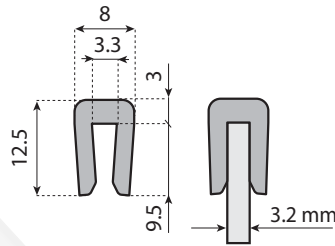
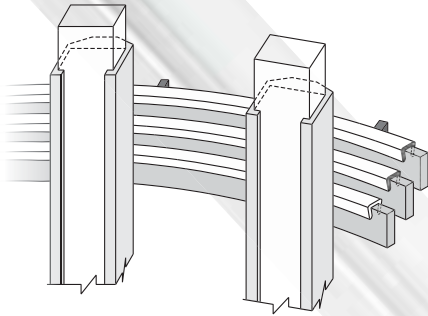

## RETURN WEAR STRIPS

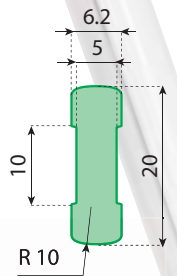
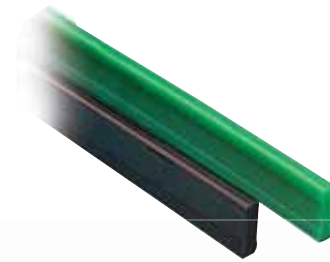

## SIDE GUIDES

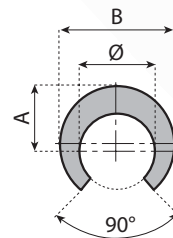
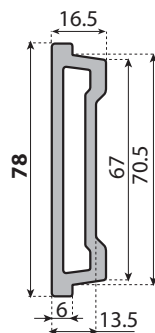
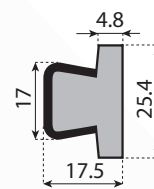
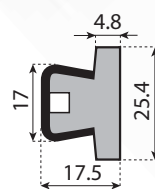
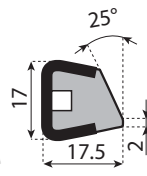
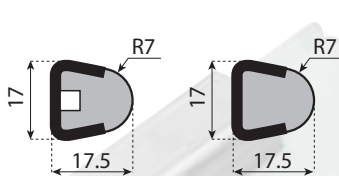

## NECK GUIDES

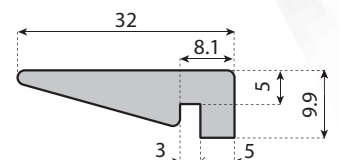
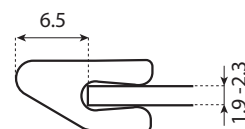
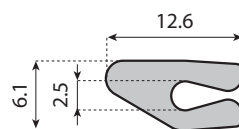
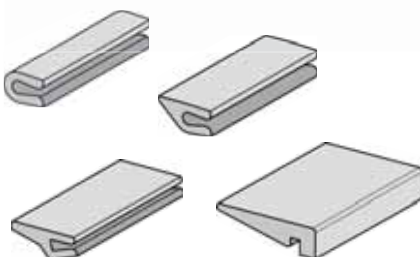



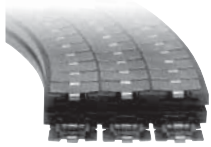

**SYSTEM  
PLAST**

**Conveying Chain**

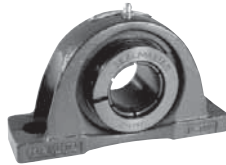

**SEALMASTER**

**Mounted Ball Bearings**



**Morse**

**Clutches**



**Browning**

**Shaft Mount Reducers**

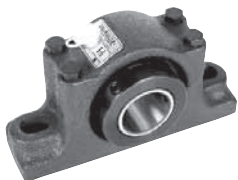

**SEALMASTER**

**Mounted Roller Bearings**



**ROLLWAY**

**Roller Bearings**



**Browning**

**V-Belt Drives**



**Morse**

**Chain**



**KOP-FLEX**

**Couplings**



**JAURE**

**Wind Couplings**



**Morse**

**Worm Gearing**



**MCGILL**

**Precision Bearings**

## System Plast S.r.l.

Via San Rocco, 29/31

24060 Telgate (Bergamo) - ITALY

**Customer Service**

**+39 035 83 51 301**

**Fax**

**+39 035 83 51 406**

**E-mail**

***info@systemplast.com***

*Full details regarding your nearest Sales contact and all information about other high quality System Plast products is available at **www.systemplast.com***



**System Plast - GERMANY**

Tel. (03529) 56 15 0 - Fax (03529) 51 13 67

[info@fspchains.com](mailto:info@fspchains.com)



**System Plast - GERMANY**

Sales Office - Tel. (06204) 9673 0 - Fax (06204) 9673 29

[info-de@systemplast.com](mailto:info-de@systemplast.com)



**System Plast - FRANCE**

Tel. (01) 64 66 05 48 - Fax (01) 64 66 05 82

[info-fr@systemplast.com](mailto:info-fr@systemplast.com)



**System Plast International - THE NETHERLANDS**

Tel. (0186) 63 61 21 - Fax (0186) 63 61 25

[info-nl@systemplast.com](mailto:info-nl@systemplast.com)



**System Plast - UK**

Tel. (01926) 614 314 - Fax (01926) 614 914

[info-uk@systemplast.com](mailto:info-uk@systemplast.com)



**System Plast - USA**

Tel. 866 589 3911 - Fax 866 447 6587

[solusteam@solusii.com](mailto:solusteam@solusii.com)



**System Plast - MEXICO**

Tel. (033) 3688 0024 - Fax (033) 3688 0036

[servicioclientes@emerson.com](mailto:servicioclientes@emerson.com)



**System Plast - BRAZIL**

Tel. (011) 3849 48 46 - Fax (011) 3845 46 02

[info-br@systemplast.com](mailto:info-br@systemplast.com)



**System Plast - SINGAPORE**

Tel. (65) 6891 7600 - Fax (65) 6873 7882

[systemplast.sg@emerson.com](mailto:systemplast.sg@emerson.com)



**System Plast - CHINA**

Tel. (86) 596 2136017 - Fax (86) 596 2136004

[sales.zz@emerson.com](mailto:sales.zz@emerson.com)

**04/2011**

**Code N. 22480/002 - MCB11007**

Morse is a registered trademark of Borg-Warner Corporation, used herein under exclusive license.  
Browning, Emerson, Emerson, Consider It Solved, Emerson Industrial Automation, Jaure, Kop-Flex, McGill, Sealmaster and System Plast are trademarks of Emerson Electric Co. or one of its affiliated companies.  
© 2011 System Plast S.r.l. All rights reserved. Printed in U.S.

**SYSTEM  
PLAST**

  
**EMERSON**  
Industrial Automation